

GDO-9 Enduro™ Gen 2

Overhead Garage Door Opener

Home Owner's Manual

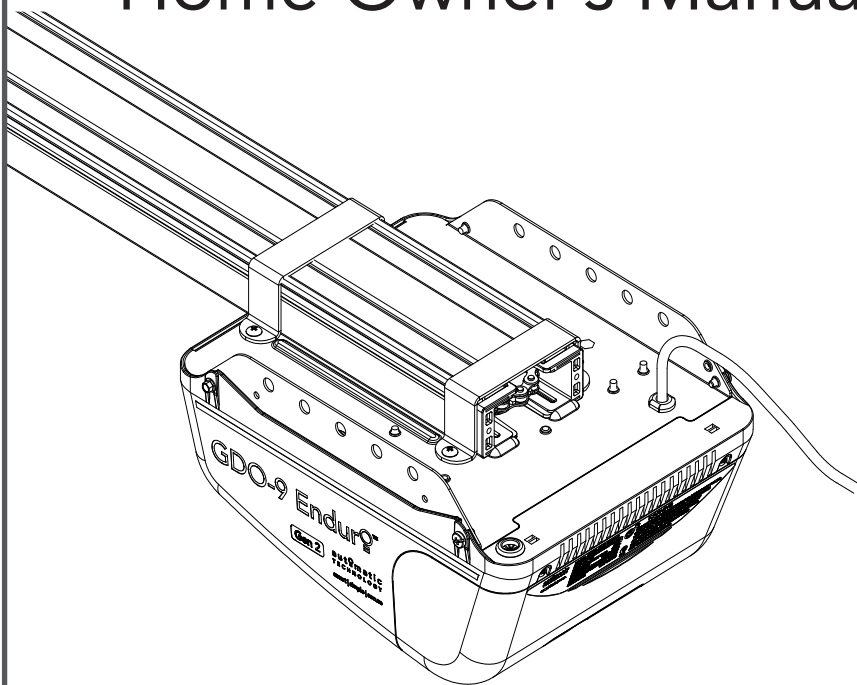

Featuring **TrioCode™ 128** Technology

Doc #: 160001_01
Part #: 13373
29/08/2013

SMART
SIMPLE
SECURE

Table of Contents

1. Safety Rules	3
2. Features	4
3. Specifications	5
4. Operating your door	6
5. User Operating Controls	7
6. Opener Safety & Security	8
6.1 Manual Door Operation	8
6.2 Emergency Evacuations	8
6.3 Power Failure	8
6.4 Re-Engaging the Opener	8
6.5 Security - Inbuilt Locking Facility	8
7. Safety Testing	9
7.1 Test the Close Cycle	9
7.2 Testing the Open Cycle	9
7.3 Test the Manual Door Operation	9
7.4 Setting the PET Mode position	9
8. Coding Transmitters	10
8.1 Setting the Transmitter to Operate the Door	10
8.2 Setting the Transmitter to Operate Vacation Mode	10
8.3 Setting the Transmitter to Operate PET (Pedestrian) Mode	10
8.4 Setting the Transmitter to Operate the Courtesy Light	11
8.5 To Erase Programmed Codes	11
8.6 Remotely Coding Transmitters	11
9. Troubleshooting Guide	12
10. Maintenance	14
10.1 Door Maintenance	14
10.2 Lubrication (every 3 - 6 months)	14
10.3 Door Service and Repair	14
10.4 Opener Maintenance	15
10.5 Service Indicator	15
10.6 Removing the Battery From the Transmitter	15
11. Warranty	16
12. Optional Accessories	18
13. Service Schedule	19

1. Safety Rules

Please read these important safety rules

This automatic garage door opener is designed and tested to offer safe service provided it is installed and operated in strict accordance with the following safety rules. Failure to comply with the following instructions may result in death, serious personal injury or property damage.



WARNING!

- When operating the manual release while the door is open, the door may fall rapidly due to weak or broken springs, or due to being improperly balanced.
- Do not disengage the opener to manual operation with children/persons or any objects including motor vehicles within the doorway.
- If the door is closing and does not re-open when obstructed, discontinue use. Do not use a door with faulty obstruction sensing.



ELECTROCUTION!

- Place opener in protected area so that it does not get wet.
- Do not spray with water .
- Do not open the protective covers.
- Do not operate opener if cable is damaged.



CAUTION:

Emergency access

Entrapment under operating door

Fall from Ladder

Entanglement in or laceration from moving door

- If your garage has no pedestrian entrance door, an emergency access device should be installed. This accessory allows manual operation of the garage door from outside in case of power failure.
- Watch the moving door and keep people away until the door is completely opened or closed. Do not operate door when persons are near the door.
- Do not allow children to play with door controls or transmitters.
- Regularly conduct Open and Close cycle testing.
- Ensure the garage door is in good working order by undertaking regular servicing.
- Wall transmitters should be installed in a location where the garage door is visible, but out of the reach of children at a height of at least 1.5m.
- Install Safety Beams (recommended).
- Ensure ladder is the correct type for the job.
- Ensure ladder is on flat ground.
- Ensure user has 3 points of contact while on ladder.
- Keep hands and loose clothing clear of door and guides at all times.
- Keep hands clear of moving door as sharp edges can cause cuts or lacerations.
- Keep the garage door balanced. Sticking or binding doors must be repaired. Garage doors, door springs, brackets and their hardware are under extreme tension and can cause serious personal injury. Do not attempt any garage door adjustment. Do not use if repair or adjustment is needed. Call for a professional garage door service.



DO NOT DO IT YOURSELF

Automatic Technology (Australia) Pty Ltd to the extent that such may be lawfully excluded hereby expressly disclaims all conditions or warranties, statutory or otherwise which may be implied by laws as conditions or warranties of purchase of a Automatic Technology (Australia) Pty Ltd Garage Door Opener. Automatic Technology (Australia) Pty Ltd hereby further expressly excludes all or any liability for any injury, damage, cost, expense or claim whatsoever suffered by any person as a result whether directly or indirectly from failure to install the Automatic Technology (Australia) Pty Ltd Garage Door Opener in accordance with the installation instructions.

SMART
SIMPLE
SECURE

2. Features

Warranty

Two (2) year/5,000 cycles full parts and labour warranty on motor, electronics and mechanical components of the opener when installed by an Automatic Technology Dealer.

TrioCode™128 Technology

Only transmitters with the TrioCode™128 Technology can operate with the latest GEN2 Openers, reducing the chance of interference from other radio frequency sources. TrioCode™128 transmitters have the ability to code into earlier model openers.

Code Hopping Technology

Every time a transmitter is used a new security code is generated from over 4.29 billion possible code combinations. This greatly enhances the security of the system and makes “code grabbing” a thing of the past!

Multi-Channel Transmitter

Multi-channel transmitters allow you to operate other devices such as an adjoining garage door or automated gate from the same handy unit.

Safety Reversing System

The automatic safety reverse system significantly reduces the risk of death or serious injury if trapped by a closing door. The safety reverse force can be adjusted for environmental conditions such as windy areas.

Memory Retention

In case of a power failure the opener does not lose the transmitter codes or limit settings.

Soft Start/Soft Stop

The opener eases into and out of each cycle making for smoother and quieter operation, as well as reducing wear and tear on the door and opener.

Manual Release

The manual release handle allows the door to be operated by hand in the event of a power failure.

Self Locking

There is no need to manually lock your garage door, as the opener ‘positively’ locks the door when closed.

Service Indicator

The opener has a built in service counter. From factory this is loaded with 3000 cycles. When this counter expires, the service yellow LED will light up and at the start of each door movement the beeper will sound three times. Contact your dealer/installer for service. (Refer to 10.5 for information).

Service Fault Indicator

Flashing LEDs on the control panel easily identify operational problems or service requirements.

Dynamic Door Profiling

Changing door characteristics are automatically compensated for and “learnt” with each operation of the door.

Vacation Mode

A transmitter can be programmed to disable the garage door opener radio receiver. This is ideal if the door is to be left idle for prolonged periods. (Refer to 8.2 for information)

Pet (Pedestrian) Mode

A transmitter can be programmed to open the door partially to allow pets access to the garage. The default PET Mode height can be adjusted to a desired position. (Refer to 7.4 for information). To code a transmitter button to operate PET mode refer to 8.3 for information.

LED Courtesy Light

Using the latest Light Emitting Diode (LED) technology, the opener features two LED's. These LED's produce a brilliant white light that illuminates the garage upon activation.

The LED courtesy light automatically switches on for approximately four (4) minutes (time programmable) when operating the door. This can also be programmed to turn on and off from a transmitter. (Refer to 8.4 for information)

3. Specifications

Technical Specifications	
Power supply	230V - 240Va.c. 50Hz
Maximum door opening: Width: Height: Weight:	6000mm (18.0m ²) 3000mm 100kg
Minimum headroom	30mm
Short Term Peak Force	1000N (100kg)
Rated force	600N (60kg) with Chain 500N (50kg) with Timing Belt
Nominal force	150N (15kg)
Receiver type	UHF Multi-frequency FM Receiver
Receiver code storage capacity	64 X 4 button Transmitter Codes
Transmitter frequency	TrioCode™ 128 Type
Coding type	Mult-frequency Code Hopping
Number of code combinations	Over 100 billion random codes
Code generation	Non-linear encryption algorithm
Transmitter battery	CR2032 (3 Volts)
Courtesy light	LED (Light Emitting Diodes)

Note: Intermittent operations may occur in areas which experience very strong winds. The strong wind puts extra pressure on the door and tracks which may in turn intermittently trigger the safety obstruction detection system.

4. Operating your door

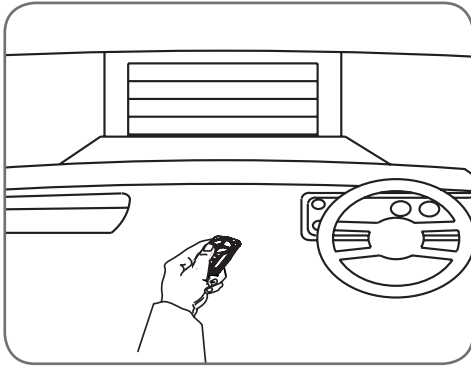

Fig. 4.1

For maximum efficiency of your opener, your garage door must be in good operating condition.

An annual service of your garage door by a Door Professional is recommended.



CAUTION: Activate the opener only when the door is in full view, free of obstructions and with the opener properly adjusted. No one should enter or leave the garage while the door is in motion. Do not allow children to play with or near the door.



ELECTROCUTION! This opener is a mains voltage plug-in domestic appliance and there are no user serviceable parts inside this opener.

Transmitter

- To operate the opener, press the programmed transmitter button until your door begins to move (usually 2 seconds). Make sure you can see the door when you use the transmitter.
- If you are in a vehicle you should aim the transmitter through your windscreen (**Fig. 4.1**).
- Check that the door is fully closed before you drive away.
- If you press the transmitter whilst the door is moving the door will stop. The next press of the transmitter will move the door in the opposite direction.

The transmitter may also be programmed to operate the following features (Refer to Section 8 for full details):

- Turn the courtesy light on and off without operating the door,
- Put the garage door opener into "Vacation Mode" where it will not respond to any transmitters.

NOTE: Additional transmitters may be purchased at any time.

5. User Operating Controls

Button (Fig 5.1)	Function
1. OPERATE	Opens/stops/closes the door
2. CODING LED (Red)	Flashes when a code is being stored or when the transmitter button is pressed
3. LIGHT CODE (White)	Is used for storing or erasing the transmitter button (code) you wish to use to switch the courtesy light on the opener on or off.
4. DOOR CODE (Blue)	Is used for storing or erasing transmitter buttons for door operation
5. OPEN LED (Green)	Illuminates and flashes as the door opens and remains on when the open limit position has been reached.
6. DOOR STATUS LED (Yellow)	Illuminates when Service is due.
7. CLOSE LED (Red)	Illuminates and flashes as the door opens closes, and remains on when the close limit position has been reached.

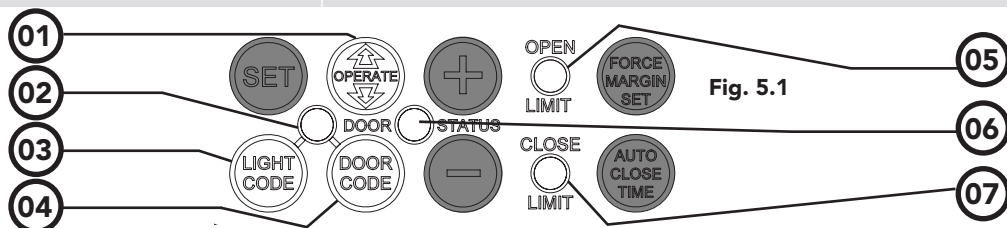

Door Status Indicators	OPEN LED (green)	CLOSE LED (red)	Beeper
Open	On		
Close		On	
Opening	Flashing		
Closing		Flashing	
Door travel stopped	Flashing	Flashing	
Door obstructed when opening	Flashing		Beeps while door is moving
Door obstructed when closing		Flashing	Beeps while door is moving
Opener overloaded	Alternating flashes	Alternating flashes	
Door in open position with Auto-Close mode selected	One second flashes		
Mains power interrupted	Rapid flashes		

6. Opener Safety & Security



WARNING! When operating the manual release (while the door is open) the door may fall rapidly due to weak or broken springs, or due to being improperly balanced.

Do not disengage the opener to manual operation with children/ persons or any objects including motor vehicles within the doorway.

MANUAL RELEASE

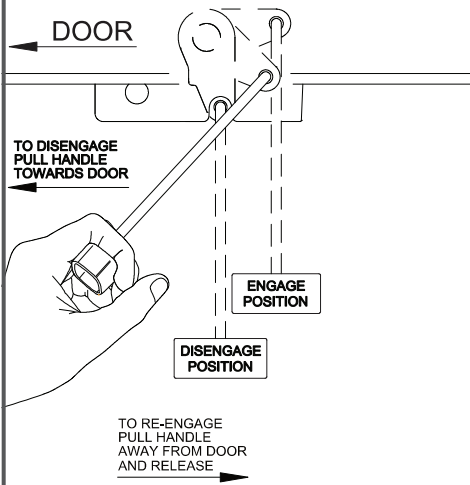

Fig. 6.1

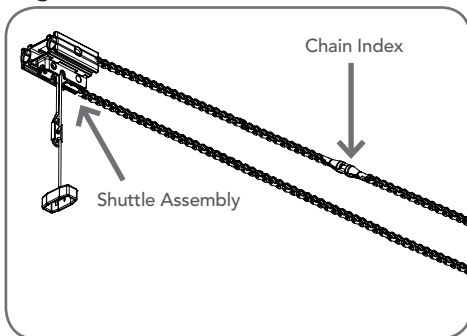

Fig. 6.2

6.1 Manual Door Operation

To disengage the opener from the door (preferably with the door in the closed position), pull down on the string handle on an angle towards the door (**Fig 6.1**). This will allow you to manually open or close the door.



CAUTION: Do not use the string handle as a mechanism to open the door. Failure to comply may cause serious injury.

To re-engage the opener pull the string handle away from the door - see 6.4 Re-Engaging the Opener.

6.2 Emergency Evacuations

In emergencies the garage door can be disengaged from the opener, via the manual release cord and the door opened manually. The manual release cord should be a maximum of 1.8m from the ground. The cord can be adjusted for special considerations.

6.3 Power Failure

When there is a power failure, the opener will be unable to automatically open or close your garage door. To use your door whilst there is no power you will need to disengage the opener and use the door manually – see 6.1 Manual Door Operation.

6.4 Re-Engaging the Opener

When the door has been disengaged from the opener, the shuttle assembly, attached to the manual release cord, can move up and down the chain. Re-engage the opener (**Fig 6.1**) (preferably with the door open to waist height) and then press the programmed transmitter button, the motor will run until the shuttle assembly engages the chain index (**Fig 6.2**), you will hear it click into place. Then the door will operate as normal.

6.5 Security - Inbuilt Locking Facility

DO NOT lock your door when your opener is engaged as it has inbuilt locking facility. With the opener engaged your door will be locked whether the power is on or off.



CAUTION: When the opener is manually disengaged, the door is no longer locked. To lock the door manually, re-engage the opener after the door is closed.

7. Safety Testing

7.1 Test the Close Cycle

- Press the transmitter to open the door. (Fig 7.1)
- Place a piece of timber approximately 40mm high on the floor directly under the door (Fig 7.2).
- Press the programmed transmitter to close door.
- The door should strike the object and re-open.

7.2 Testing the Open Cycle

- Press the transmitter to close the door (Fig. 7.1).
- Press again to open the door.
- When the door reaches approximately half way, firmly grab the door's bottom rail - the door should stop.

If the door does not reverse readily when closing, or stop when opening, put the door into manual and contact your installer immediately for a door service.

7.3 Test the Manual Door Operation

Periodically disengage the opener (Section 6.1) and manually operate the door. The door must be smooth to operate by hand. The force required on the bottom rail should not exceed 15 kg.

7.4 Setting the PET Mode position

When activated, PET mode drives the door to the preset position from the close position.

- Drive and stop the door at the desired PET mode open position by pressing the transmitter button coded for Open/Stop/Close operation.
- Press and hold the OPEN button on the opener for six (6) seconds until the OPEN and CLOSE LED's are lit to record the new PET position.

To program a transmitter button to operate PET mode refer to 8.3 Code Transmitter for PET Mode.

Periodically test if a PET mode button is pressed, while the door is moving, the door will stop or when the door is in the PET position, the door will close.



CAUTION: Take care when completing a safety test. Failure to follow this warning can result in serious personal injury and/or property damage.



WARNING! If the door is closing and is unable to re-open when obstructed, discontinue use. Do not use a door with faulty obstruction sensing. Contact your dealer for support.

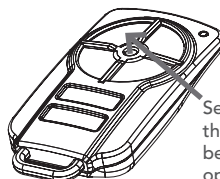

Select the button on the transmitter that has been programmed to operate the door.

If transmitter is not programmed, Refer to Section 8 to program transmitter.

Fig. 7.1

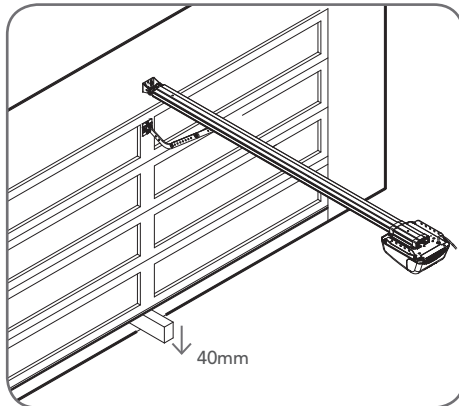

Fig. 7.2

8. Coding Transmitters

8.1 Setting the Transmitter to Operate the Door

The opener can only operate from transmitters that have been programmed into its receiver. The receiver needs to learn the codes of any transmitter that will be used with the opener. Up to sixty four (64) codes can be stored in the receiver's memory.

- Ensure the button cover has been removed (see Electrocutation caution) and the opener is turned on.
- Press and hold the DOOR CODE button. The DOOR CODE LED will illuminate and beep to indicate the opener is in Code Learn mode (**Fig. 8.1**).
- Press and hold the transmitter button that you want to control the door for two (2) seconds, pause for two (2) seconds, then press the same button again for two (2) seconds and release.
- Release the DOOR CODE button.
- Press the transmitter button to test.

8.2 Setting the Transmitter to Operate Vacation Mode

The opener can be programmed into a "Vacation Mode" where the opener will not respond to any transmitter except one preprogrammed unit.

- Briefly press the DOOR CODE button once, then press it again and hold (will beep two times on second press (**Fig. 8.2**).
- Press one of the four (4) buttons on the transmitter for two (2) seconds, pause for two (2) seconds, then press the same button again for two (2) seconds.
- Release DOOR CODE button.
- Press and hold the transmitter button for six (6) seconds to set Vacation Mode. The door code LED will stay lit while Vacation Mode is active.

To reset Vacation Mode, press the same transmitter button for two seconds.

8.3 Setting the Transmitter to Operate PET (Pedestrian) Mode

- Briefly press the DOOR CODE button three (3) times, then press it again and hold (the opener will beep four times on the fourth press).
- Choose a transmitter button not already coded into the receiver. Press and hold this button for two (2) seconds, pause for two (2) seconds, then press the same button again for two (2) seconds and release.
- Release the DOOR CODE button.
- Press the transmitter button to test.



ELECTROCUTION! The button cover is the only cover that should be removed. All other covers must remain in place.



CAUTION: Be careful not to press the operate button while removing the button cover as the door will start to move.

IMPORTANT NOTE: Only TrioCode™128 Technology Transmitters are compatible with this GDO-9 GEN2 product.

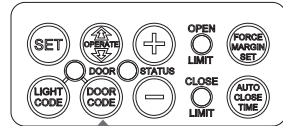

Press and hold DOOR CODE button



Select one of the four buttons you wish to use to control the door

Fig. 8.1

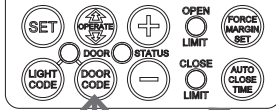

Press DOOR CODE button twice.



Select one of the four buttons (not programmed yet) you wish to use to control the Vacation Mode

Fig. 8.2

8. Coding Transmitters

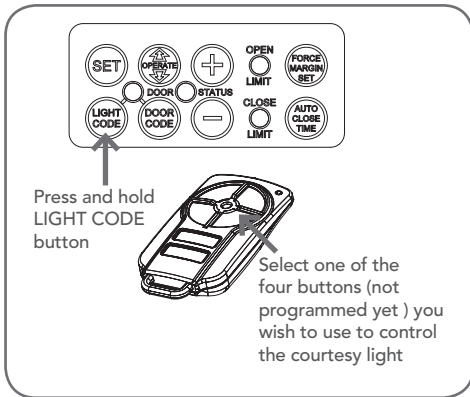

Fig. 8.3

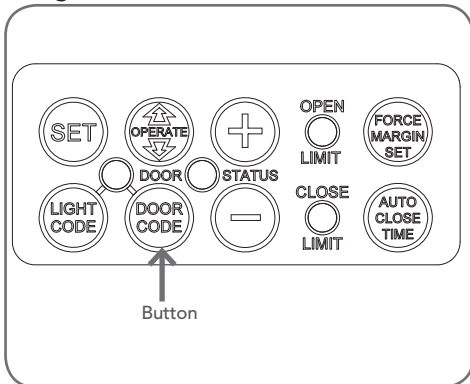

Fig. 8.4

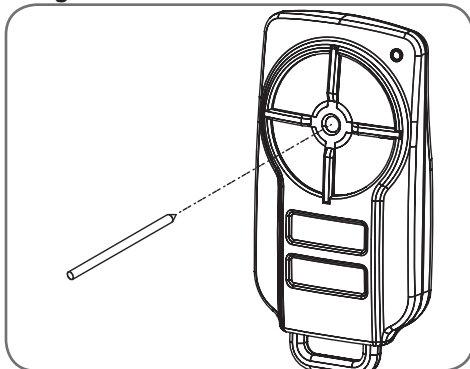

Fig. 8.5

8.4 Setting the Transmitter to Operate the Courtesy Light

Although the courtesy light comes on with each operation of the opener, it may also be controlled by a transmitter without operating the door.

- Press and hold the LIGHT CODE button. The LIGHT CODE LED will illuminate and the courtesy light will turn on to indicate that the light code learning is active (**Fig. 8.3**).
- Choose a transmitter button not already coded into the receiver. Press and hold this button for two (2) seconds, pause for two (2) seconds, then press the same button again for two (2) seconds and release.
- Release the LIGHT CODE button.
- Press the transmitter button to test.

8.5 To Erase Programmed Codes

- Select the transmitter you want to delete.
- Press and hold the DOOR CODE BUTTON (**Fig. 8.4**).
- Press the transmitter button you would like to delete for two seconds, pause for two seconds, press again for two seconds and then release. Release the DOOR CODE BUTTON. The code should now be deleted. Confirm this by pressing the transmitter button - the function (e.g. door opening) should not respond.

8.6 Remotely Coding Transmitters

Using this method transmitters can be coded without access to the opener's control panel as long as a pre-coded transmitter is available.

- Take any pre-coded transmitter. Press the button for the function to be duplicated and release.
- Using a small needle / pen, press and hold firmly for two seconds the middle button, through the Coding Hole (**Fig. 8.5**).
- Within ten (10) seconds take the additional transmitter you wish to code. Hold the new transmitter's button for two seconds, pause for two seconds, hold again for two seconds and then release.
- Wait for ten (10) seconds and then press the new transmitter's button to test.

9. Troubleshooting Guide

Symptom	Possible cause	Remedy
The opener does not work from the transmitter	Garage door in poor condition e.g. springs may be broken	Check the door's operation - see monthly maintenance (Section 10.1)
	The opener does not have power	Plug a device of similar voltage (e.g. a hairdryer) into the power point and check that it is OK
	The battery in the transmitter is flat	Replace the battery (Section 10.6)
	Transmitter does not contain TrioCode™128 Technology	Check that the transmitter has grey buttons and the model number on the back displays V2. Contact dealer for support if otherwise.
	The opener has been put into "Vacation Mode"	Turn off "Vacation Mode" (Section 8.2, step e)
	The transmitter button is not programmed to operate the door.	See coding transmitter procedure (Section 8.1)
Door Code LED is flashing yet the opener is not working.	Ensure the correct button on the transmitter is being pressed.	
The chain moves but the door remains stationary	The opener is disengaged	Re-engage the opener (Section 6.4)
Motor is running but chain is not moving	Damage motor assembly	Contact your dealer for support.
The transmitter range varies or is restricted	Variations are normal depending on conditions e.g. temperature or external interference	See instructions for correct use of transmitter (Section 4)
	The battery life is exhausted	Refer to battery status (Fig 10.3)
	Position of the transmitter in the motor vehicle	Change the position (Section 4)
The door reverses for no apparent reason	This may occur occasionally from environmental conditions such as areas that are windy, dusty or have extreme temperature changes.	Put the door into manual (Section 6.1, take note of the CAUTION) and contact your dealer.
	If Safety beams are installed they may be partially obstructed.	Ensure the beam path is not obstructed. If continues, contact your dealer.
The door opens but will not close	Safety Beam (Optional Accessory) not operating correctly	Contact your dealer for support

9. Troubleshooting Guide

Symptom	Possible cause	Remedy
The door stops or moves very slowly under battery (Optional Battery Back Up Accessory)	The batteries may have little to no charge	Connect mains power and leave the batteries to charge. The batteries may take 24 to 48 hours to reach their maximum charge capacity.
Courtesy Light flashes and the opener beeps 5 times after each operation	The opener has reached the number of cycles recommended before servicing.	See (Section 10.5) Contact your dealer and arrange a door service. Alternatively press SET button once to reset the service counter.
The SERVICE LED has started to flash and is beeping numerous times	A Fault has been detected. The fault will be active each time an attempt is made to operate the door.	Record opener function in (Fig 9.1) then press the SET button once to reset the opener. If the fault continues to be tripped contact your dealer for support.
The Open (Green) LED and Close (Red) LED are flashing alternatively	Opener is overloaded	Discontinue use and Contact your dealer for support.
The Open (Green) LED continues to flash	Door obstructed when opening	Clear away any obstructions and test door opens correctly. (If door is damaged, contact your dealer).
The Close (Red) LED continues to flash	Door obstructed when closing	Clear away any obstructions and test door closes correctly. (If door is damaged, contact your dealer).
	Limits may be cleared	Remove all power sources (including the battery backup). Wait till all lights are out (10-15 secs), then reconnect power. If Red LED is flashing, limits are not set. Contact dealer immediately and discontinue use.

If You Need a Service Call

If the opener needs a service please call the dealer who installed the garage door opener (their contact details are usually on a sticker on the back of your garage door). For product assistance contact 1300 133 944 within Australia.

Date	Time	Number of Beeps

Fig. 9.1

BEFORE CALLING you should have the following information to assist in providing the appropriate service:

1. Has anything happened since the opener last operated OK, e.g. a storm, a jolt to the door etc.?
2. What is the current light status on the opener?
3. Manually disengage the door (Section 6.1). How easy is it to manually open and close the door?
4. What model is the opener? (Model no. information is located at the rear of the opener)
5. Who installed the opener? (Dealer details should be on a sticker on the back of your garage door)
6. When was it installed? (If known)

10. Door Maintenance



WARNING! Failure to maintain your garage door may void the warranty on your garage door opener.



DO NOT DO IT YOURSELF: Door adjustments should only be carried out by experienced persons, as this function can be dangerous if not performed under strict safety procedures.



ELECTROCUTION! Disconnect the opener power cord from the mains power before making any door repairs / maintenance or removing the opener button cover.

10.1 Door Maintenance

Whilst your opener does not require any periodic maintenance, the door that it is fitted to, does. Your garage door is a large, heavy, moving object and should be tested regularly to ensure it is in good condition. A poorly maintained door could cause fatal / serious injuries or damage to property.

- Frequently examine the door, particularly the cables, springs and mountings for signs of wear, damage or imbalance. **DO NOT USE** if repair or adjustment is needed since a fault in the installation or an incorrectly balanced door may cause injury.

10.2 Lubrication (every 3 - 6 months)

To ensure a long and trouble free life for your door the following is recommended:

- Guide Tracks: Clean the internal sections of the guide tracks with a cloth dampened with mineral turps or methylated spirits.
- Steel Hinges (if fitted): Sparingly lubricate with an all-purpose machine oil. Also lubricate wheel to axle bearings.
- Plastic Hinges: No lubrication is generally required; however silicon spray may be used if necessary.
- Springs: If accessible wipe over with an oily rag.

10.3 Door Service and Repair

If correct maintenance and servicing are not carried out, warranty may be void. To keep your door running well, it is recommended that your door be serviced by an experienced technician, every 12 months or earlier if required:

- Lifting Cables (if fitted): Check for wear through rubbing. If there is fraying or signs of corrosion contact your dealer immediately and discontinue use, leaving door in the closed position.
- Fasteners: Check all screws, nuts and bolts to ensure they are secure.
- Spring Tension: It is natural for springs to lose tension. Should the door become hard to operate or completely inoperative, contact your dealer.

10. Opener Maintenance

10.4 Opener Maintenance

To ensure a long and trouble free life for your opener the following is recommended:

- Monthly: Run the Safety Testing procedures in Section 7 to ensure garage door is fit for use.

NOTE: If the door does not operate smoothly, call your nearest Approved Dealer.

10.5 Service Indicator

While the door opener does not require regular servicing, to function correctly the door must be in good operating condition. As a reminder the Enduro™ has a built in maintenance counter. This counter has a factory default of 3000 cycles, which is the recommended service interval.

When this counter expires the yellow SERVICE LED will light up and opener beep three times at the start of each cycle (**Fig. 10.1**). In addition the courtesy light will flash and opener beep five times at the end of open cycle (when the door is fully open).

These warning signals will self extinguish after 30 cycles. **When this service counter is triggered it is strongly recommended you contact your garage door dealer to arrange a door service.** See Section 13 for Recommended Service Schedule.

However, if you choose not to have your door serviced the counter can be reset simply by pressing the LIMIT SET button.

10.6 Removing the Battery From the Transmitter

(Battery Type: 3V Lithium Battery CR2032).

Use a non-metallic object (e.g. pen) to remove the battery. (**Fig. 10.2**). To test the battery is working, press and hold a transmitter button; (**Fig. 10.3**).

Light Status	Battery Status
Solid	OK
Flashing	Requires replacement
No light	Requires replacement

Fig. 10.3

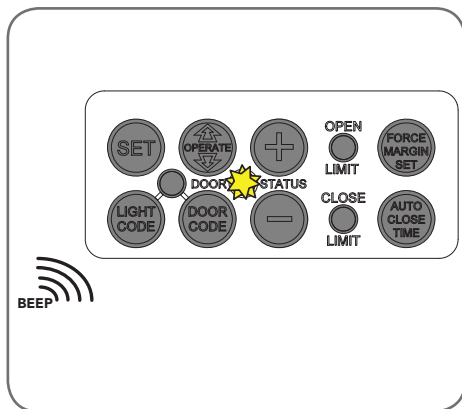

Fig. 10.1

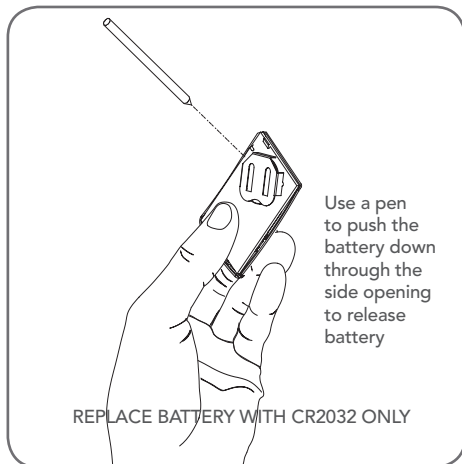

Fig. 10.2

11. Warranty

Product: GDO-9 Enduro™ GEN2

Purchased from: _____ Purchaser: _____
(described as “you” below)

Address: _____ Installed by: _____

Installed on (date): _____ Invoice No: _____

- This Warranty is given by Automatic Technology (Australia) Pty Ltd (ABN 11 007 125 368) (ATA), 6-8 Fiveways Boulevard, Keysborough 3173, 1300 133 944, sales@automatictechnology.com.au
2. The Competition and Consumer Act 2010 (including the Australian Consumer Law) and other relevant statutes provide a set of statutory consumer guarantees and other legal rights that cannot be excluded, restricted or modified by contract. This Warranty is in addition to and does not affect any of your rights under the Australian Consumer Law and other relevant statutes.
 3. Our goods come with guarantees that cannot be excluded under the Australian Consumer Law. You are entitled to a replacement or refund for a major failure and for compensation of any other reasonably foreseeable loss or damage. You are also entitled to have the goods repaired or replaced if the goods fail to be of acceptable quality and the failure does not amount to a major failure.
 4. Subject to your non-excludable rights under the Australian Consumer Law, ATA expressly excludes any liability for consequential loss, incidental or indirect damages (including but not limited to damages for loss of business profits, business interruption and loss of business information) due to a defect of the GDO-9 Enduro™ (Gen 2) (Product). In particular any loss or damage caused to other equipment or accessories used with the product or any loss resulting from a delay in repair is excluded to extent permitted by law.
 5. Subject to all of the matters set out below, ATA warrants in relation to the Product that:
 - (a) the Product's drive units will be free of any defects in material and workmanship for at least 24 months after the date of purchase (as evidenced by the sales docket receipt), or 5000 cycles, whichever ever occurs first; and
 - (b) the Product's other components and accessories will be free of any defects in material and workmanship for at least 12 months after the date of purchase (as evidenced by the sales docket receipt).
 6. No additional warranty will apply for Products repaired during the relevant warranty period.
 7. For all Products repaired outside the warranty period, a six (6) month warranty that the Product will be free of any defects in material and workmanship will apply from the date of dispatch of the Product to you. ATA may charge you for any repairs undertaken outside the warranty period, and will provide you with a quotation in relation to any such costs for your approval before proceeding with any repairs.
 8. This Warranty applies only where you:
 - (a) immediately notify ATA at the contact details provided in paragraph 1 above or notify the or the retailer that you purchased the Product from of the alleged defect;
 - (b) return the product to the retailer that you purchased the Product from; and
 - (c) present the relevant sales docket and this Warranty document to the retailer to confirm the date of purchase.
 9. Except for this Warranty, ATA gives no warranties of any kind whatsoever (whether express or implied), in relation to the product, and, subject to paragraph 1 above, all warranties of whatsoever kind relating to the product are hereby excluded.

11. Warranty

10. This Warranty excludes damage resulting from:
- normal wear and tear;
 - accidental damage;
 - incorrect installation of the Product;
 - blown fuses, electrical surges, power surges or power spikes;
 - theft, fire, flood, rain, water, lightning, storms or any other acts of God;
 - any installation, configuration or use of the Product contrary to the instructions supplied with the Product;
 - maximum continuous operating time exceeding 1 minute in 10;
 - the operating force exceeding 15kg* (150 Newton) when moving the door manually to the open or closed position;
 - the door surface area exceeding 18m² for GDO-9 Enduro™ **Gen2**;
 - the door used with the Product not being in safe working order and condition;
 - repairs which are not authorised by ATA;
 - any failure to install or maintain the Product in accordance with the instructions supplied with the Product;
 - any use which is not in accordance with the instructions provided with the Product;
 - deliberate or negligent damage to the Product;
 - any unauthorised modification to the Product;
 - faulty or unsuitable wiring in the building in which the Product is installed;
 - damage caused by insects;
 - any cost or expense relating to the recall of the Product;
 - installation of a residential garage door opener in a commercial or industrial premises or in a dwelling other than a single-family dwelling;
 - radio or electrical interference; or
 - acts or omissions of any person (including service providers approved by ATA) other than ATA.
11. ATA's liability under this Warranty is limited, at ATA's absolute option, to replacing or repairing the product which ATA, in its unfettered opinion, considers to be defective either in material and/or workmanship or to credit the dealer with the price at which the product was purchased by the dealer.
12. This Warranty does not extend to cover labour for installation of the Product following repairs, the cost of which must be borne by you.
13. This Warranty is limited to Return-to-Base (RTB) repair and does not cover labour for on-site attendance, the cost of which must be borne by you.
14. Except as specified in this Warranty, ATA will not charge you for any repairs or replacements conducted under the Warranty. However, ATA will charge you for any repairs which are not within the scope of this Warranty (or which are not required to be undertaken free of charge pursuant to the Australian Consumer Law).
15. This Warranty is void if the Product is not returned to the manufacturer in original or suitably secure packaging.
16. This Warranty is only applicable for repairs to the product carried out within Australia.
17. This Warranty does not cover consumable items including, without limitation, globes, batteries and fuses.
18. This Warranty is not transferable.
19. Where the Product is retained by any person other than ATA, except for the warranty set out above, such person has no authority from ATA to give any warranty or guarantee on ATA's behalf in addition to the warranty set out above.
20. Any provision of this Warranty that is prohibited or unenforceable in any jurisdiction is ineffective as to that jurisdiction to the extent of the prohibition or unenforceability. That does not invalidate the remaining provisions of this Warranty nor affect the validity or enforceability of that provision in any other jurisdiction.
21. Products presented for repair may be replaced by refurbished goods of the same type rather than being repaired. Refurbished parts may be used to repair the Product.

NOTES:

- One (1) cycle = one (1) open and one (1) close action of the door.
- This Warranty is to be read in conjunction with the owner's copy of the installation instruction manual.
- * The door that the Product is used with should be balanced in such a way that the user is able to open or close the door manually using a force not greater than 150 Newton (15 kg), other than to initially cause the door to start moving, which may require force in excess of that specified in this paragraph.

12. Optional Accessories

There are a range of additional accessories for your added convenience and security. Contact your dealer for installation of these accessory items.



- **Safety Beams** - Provides additional protection if the door is closing onto your property or person. Simply breaking the beam "stops" the door! Auto-Close is only possible when Safety Beams are installed.

IMPORTANT NOTE:
Only TrioCode™ 128 Technology Transmitters and Keypads are compatible with this GDO-9V2 GEN2 product.

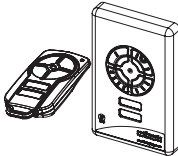

- **Keyring Transmitter** - Ideal for personal use when entry into the house may be via the garage.
- **Wall Button Transmitter** - Allows you to operate the opener within 10 metres of the door. Ideal for mounting inside the house.

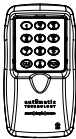

- **Wireless Keypad** - The entry keypad allows entry to the garage without using a transmitter.

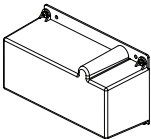

- **Battery Back-up** - The opener has a provision for a Battery Back Up kit that allows continued operation of the door in the absence of mains power.

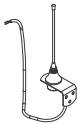

- **External Antenna** - For sites where radio range may be reduced.

13. Service Schedule

Year / Approx. Cycles	Date	Details
1 / 3,000		
2 / 6,000		
3 / 9,000		
4 / 12,000		
5 / 15,000		

Automatic Technology (Australia) Pty Ltd
 Phone: 1300 133 944
 Website: www.automatictechnology.com.au

Is your opener beeping and flashing?

**It may be time for a service
(for more details see section 10.5)**

**For a service contact your dealer using
the details below...**



Dealer: